

CRYSTAL

VERTICAL MULTI-DECK



Kaplanlar



CRYSTAL

VERTICAL MULTI-DECK





Benefits & Specifications:

- User-friendly
- Simplified maintenance
- Easy access and ergonomic design
- Designed for modular configurations
- Large display area
- Easily adapted to retrofit projects

Dimensions (mm):

Height : 2050 / 2200

Length : 1250 / 1875 / 2136 (HC) / 2500 / 2812,5 / 3125 / 3750

Depth : 950 / 1020 / 1120

| SYSTEM | OPERATING TEMP. °C | REFRIGERANT |
|--------|-------------------------------|---|
| REMOTE | -1 / +1 +2 / +4 +4 / +6 | HFC blend HFC/HFO blend CO ₂ GLYCOL/WATER |

HFC: R407A / R407F / R134a / R404A • HFC/HFO: R448A / R449A / R452A / R450A
CO₂: R744 • GLYCOL/WATER: R718



ACCESSORIES



SOLID SHELF

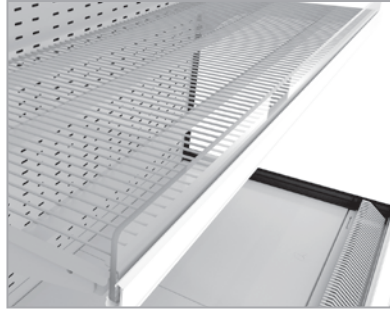

WIRE SHELF

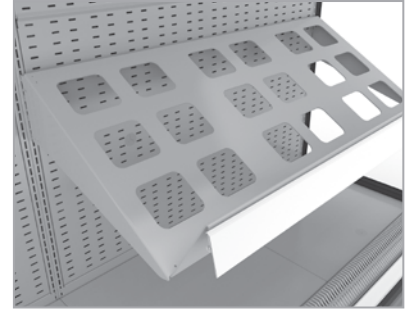

RACK SHELF

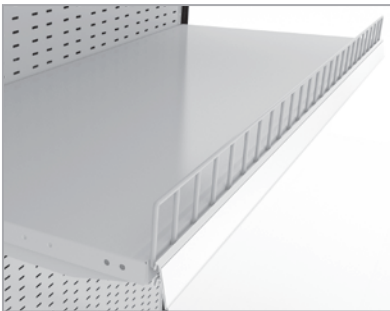

WIRE SHELF RISER



PLEXI SHELF RISER

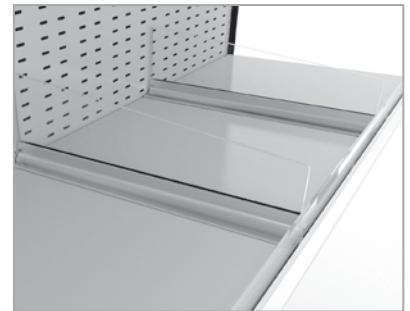

PLEXI PRODUCT DIVIDER

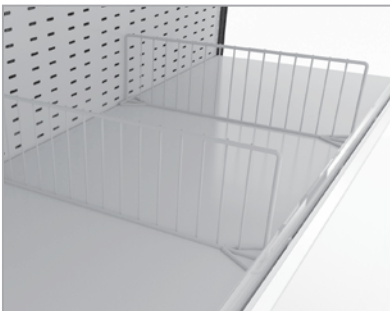

WIRE PRODUCT DIVIDER



SHELF LIGHTING

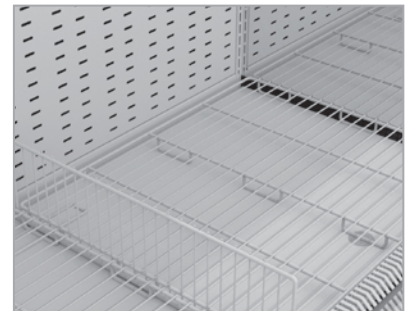

WIRE BASE TRAY
WIRE BASE PRODUCT DIVIDER

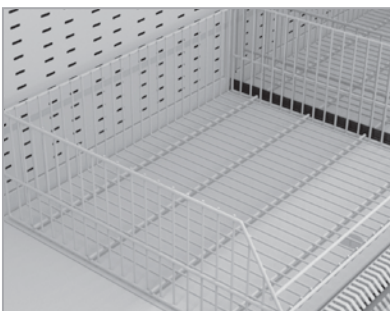

WIRE BASKET

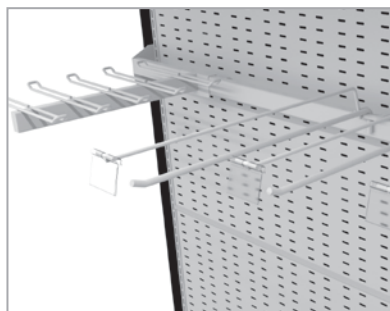

HOOK BAR



CABINET UPSTAND

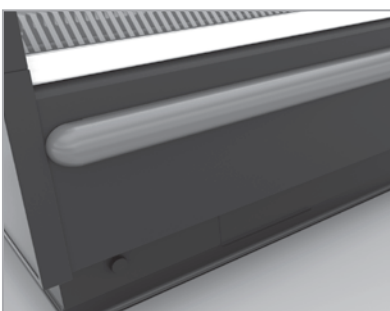

PLASTIC BUMPRAIL

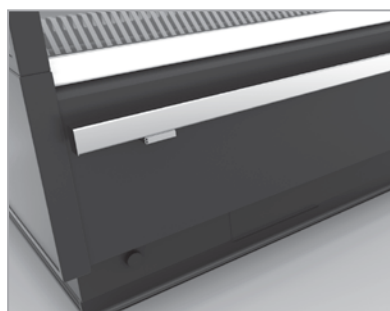

STAINLESS STEEL BUMPRAIL

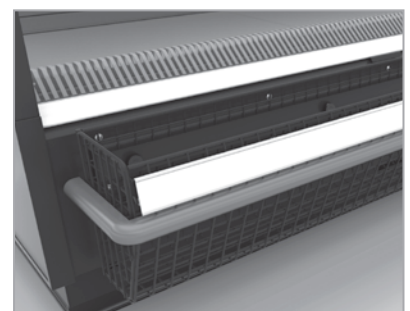

BASE FRONT CRISP BASKET



NIGHT BLIND



MIRROR (FV & MT)

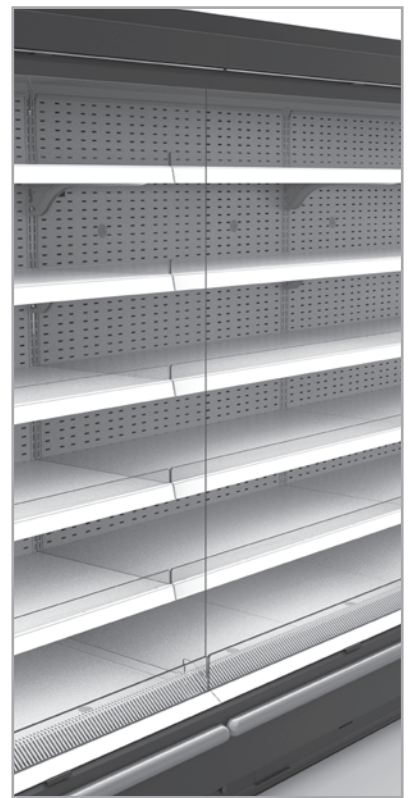

ACRYLIC SYSTEM DIVIDE



PANAROMIC SIDE PANEL



INTERMEDIATE SIDE PANEL

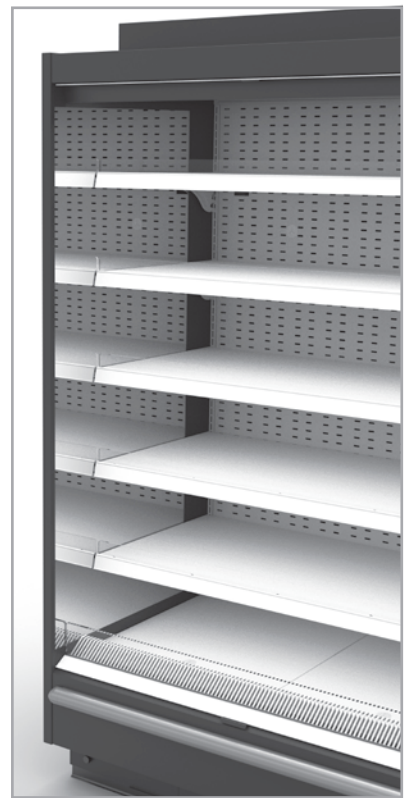

MIRRORED SIDE PANEL



TECHNICAL DATA

HEIGHT 2050

DEPTH 950

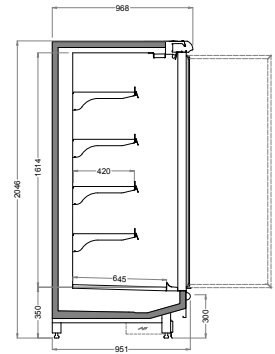
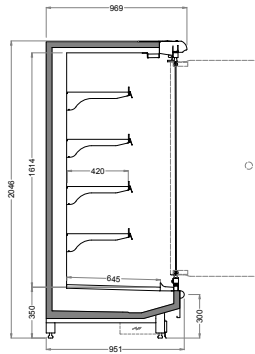
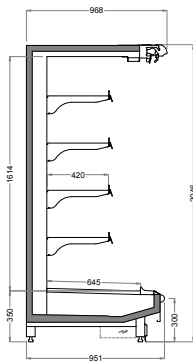

With Single Glass Doors

With Double Glass Doors

CRYSTAL V3 2050 / 950

CRYSTAL V3 2050 / 950

CRYSTAL V3 2050 / 950

| | | | | |
|-----------|--------|------|-----------|------|
| Length mm | 1250 | 1875 | 2500 | 3750 |
| | 2812,5 | 3125 | 2136 (HC) | |

| | | | | |
|-----------|--------|------|-----------|------|
| Length mm | 1250 | 1875 | 2500 | 3750 |
| | 2812,5 | 3125 | 2136 (HC) | |

| | | | | |
|-----------|--------|------|-----------|------|
| Length mm | 1250 | 1875 | 2500 | 3750 |
| | 2812,5 | 3125 | 2136 (HC) | |

DEPTH 1020

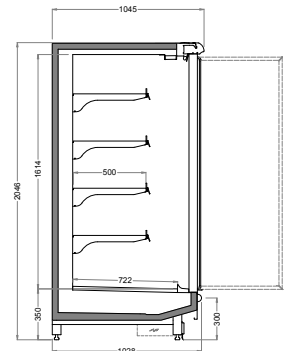
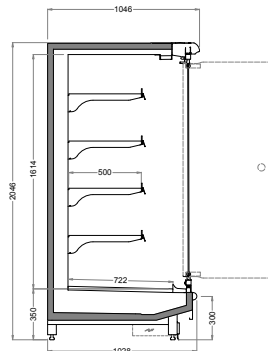
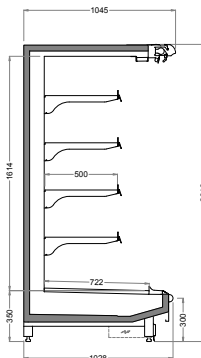

With Single Glass Doors

With Double Glass Doors

CRYSTAL V3 2050 / 1020

CRYSTAL V3 2050 / 1020

CRYSTAL V3 2050 / 1020

| | | | | |
|-----------|--------|------|-----------|------|
| Length mm | 1250 | 1875 | 2500 | 3750 |
| | 2812,5 | 3125 | 2136 (HC) | |

| | | | | |
|-----------|--------|------|-----------|------|
| Length mm | 1250 | 1875 | 2500 | 3750 |
| | 2812,5 | 3125 | 2136 (HC) | |

| | | | | |
|-----------|--------|------|-----------|------|
| Length mm | 1250 | 1875 | 2500 | 3750 |
| | 2812,5 | 3125 | 2136 (HC) | |

DEPTH 1120

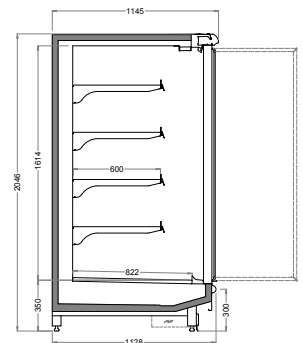
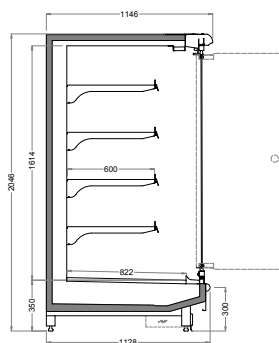
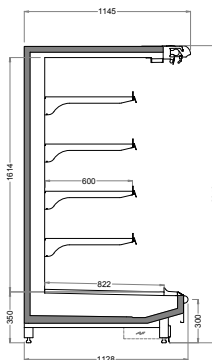

With Single Glass Doors

With Double Glass Doors

CRYSTAL V3 2050 / 1120

CRYSTAL V3 2050 / 1120

CRYSTAL V3 2050 / 1120

| | | | | |
|-----------|--------|------|------|------|
| Length mm | 1250 | 1875 | 2500 | 3750 |
| | 2812,5 | 3125 | | |

| | | | | |
|-----------|--------|------|------|------|
| Length mm | 1250 | 1875 | 2500 | 3750 |
| | 2812,5 | 3125 | | |

| | | | | |
|-----------|--------|------|------|------|
| Length mm | 1250 | 1875 | 2500 | 3750 |
| | 2812,5 | 3125 | | |

HEIGHT 2200

DEPTH 950

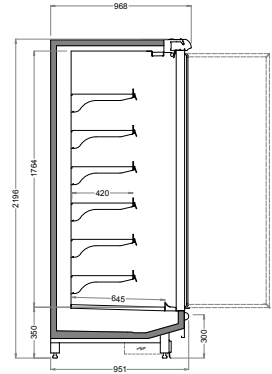
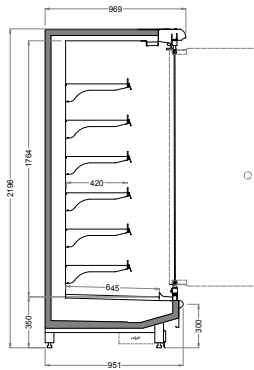
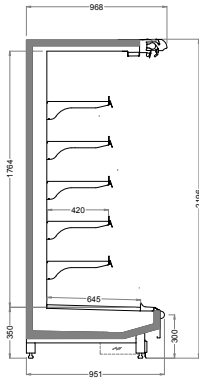

CRYSTAL V3 2200 / 950

CRYSTAL V3 2200 / 950

CRYSTAL V3 2200 / 950

With Single Glass Doors

With Double Glass Doors

Length mm | 1250 | 1875 | 2500 | 3750
2812,5 | 3125 | 2136 (HC)

Length mm | 1250 | 1875 | 2500 | 3750
2812,5 | 3125 | 2136 (HC)

Length mm | 1250 | 1875 | 2500 | 3750
2812,5 | 3125 | 2136 (HC)

DEPTH 1020

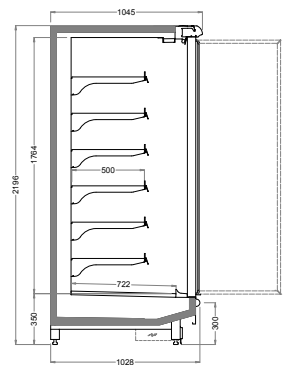
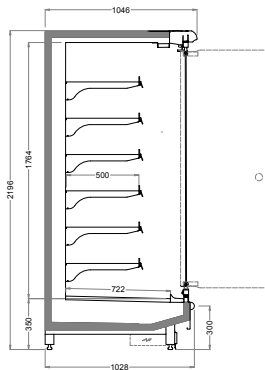
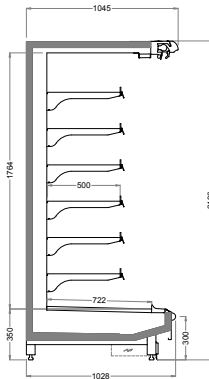

CRYSTAL V3 2200 / 1020

CRYSTAL V3 2200 / 1020

CRYSTAL V3 2200 / 1020

With Single Glass Doors

With Double Glass Doors

Length mm | 1250 | 1875 | 2500 | 3750
2812,5 | 3125 | 2136 (HC)

Length mm | 1250 | 1875 | 2500 | 3750
2812,5 | 3125 | 2136 (HC)

Length mm | 1250 | 1875 | 2500 | 3750
2812,5 | 3125 | 2136 (HC)

DEPTH 1120

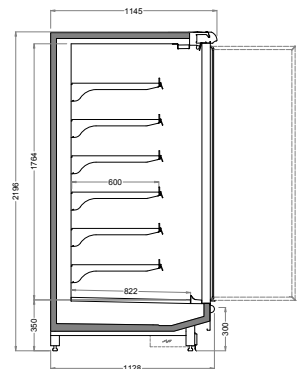
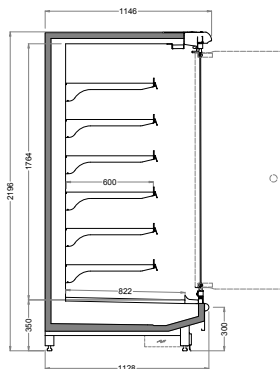
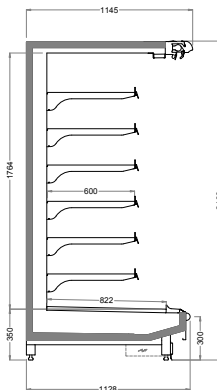

CRYSTAL V3 2200 / 1120

CRYSTAL V3 2200 / 1120

CRYSTAL V3 2200 / 1120

With Single Glass Doors

With Double Glass Doors

Length mm | 1250 | 1875 | 2500 | 3750
2812,5 | 3125

Length mm | 1250 | 1875 | 2500 | 3750
2812,5 | 3125

Length mm | 1250 | 1875 | 2500 | 3750
2812,5 | 3125



TECHNICAL DATA

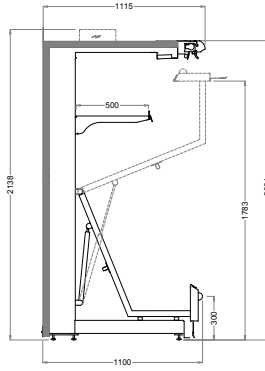

CRYSTAL V3 2050 LIFT UP

Length mm | 1250 | 1875 | 2500 | 3750

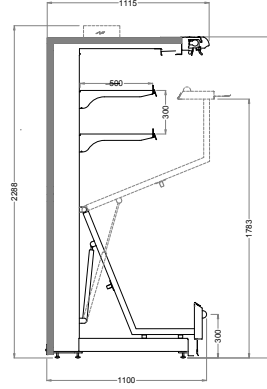

CRYSTAL V3 2200 LIFT UP

Length mm | 1250 | 1875 | 2500 | 3750

ISLAND CONFIGURATION

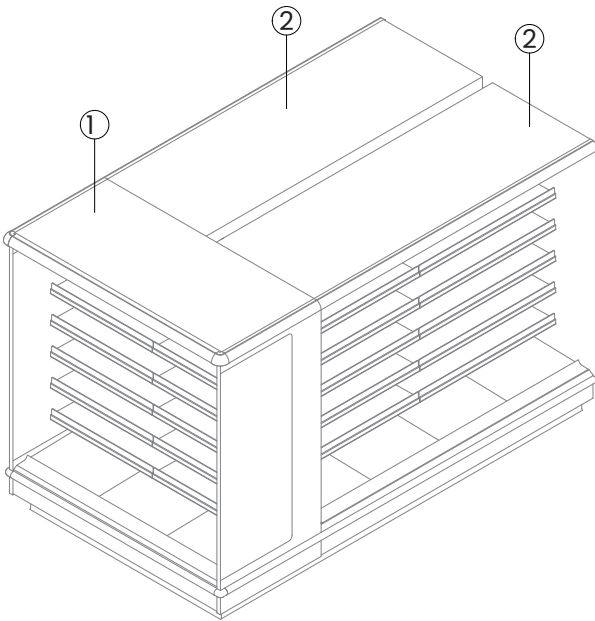

① END CASE

② RUN CASE

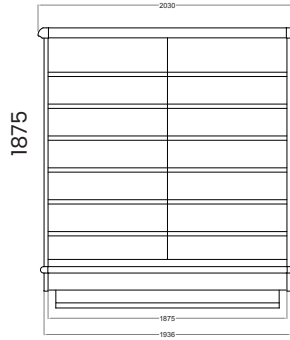

1875

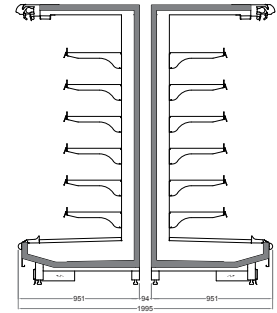

If Crystal V3 950 run cabinets are positioned back to back

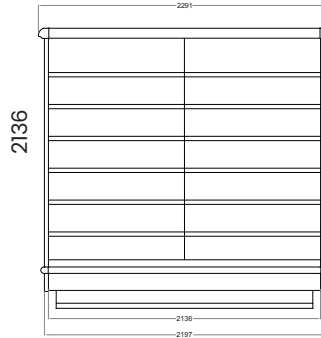

2136

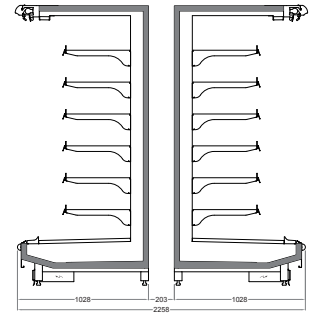

If Crystal V3 950 / 1020 run cabinets are positioned back to back

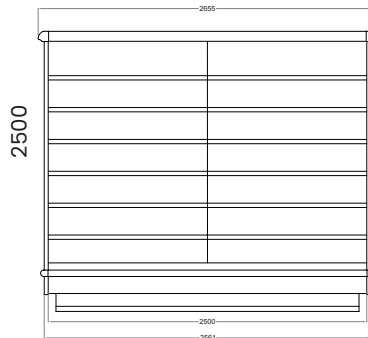

2500

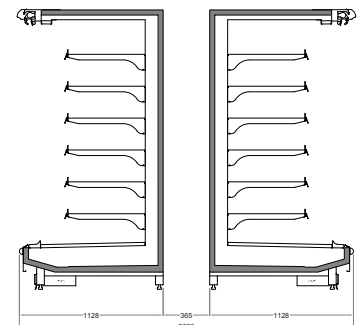

If Crystal V3 1120 run cabinets are positioned back to back